

Pro-face

by **Schneider Electric**

Operator Interface Plus Control

LT4000M SERIES

flexible



LT4000M Series

Display + Control Hybrid Model enables more flexible and space saving installations.

All-in-one Unit

All-in-one design makes it easy to keep equipment compact and allows installation in a $\phi 22$ mm hole for easy panel mounting. * Easily troubleshoot equipment by replacing the display unit or the control unit.

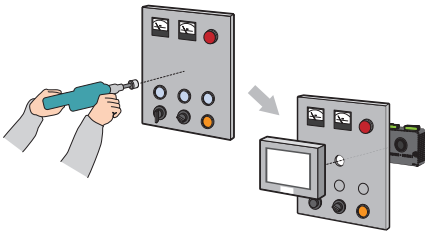

* The 22mm hole is the standard size used for buttons or lamps.

Flexible Installation

Use a separation cable* to install the control unit on a DIN rail and the operation unit in a different location. Operation unit is space-saving, and it allows you to install flexibly even where it is difficult to install due to limitations of space.

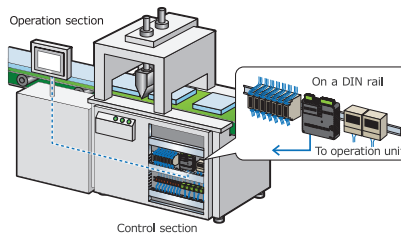

* 3m and 5m cables are available.

Compact Size



The crisp display let you create easy-to-read yet detailed operation screens. The integrated control functionality provides Digital I/O, Analog I/O, and Analog temperature inputs as well as USB, serial, and Ethernet communication ports.



Lineup

LT4000M Series

LT3000 Series

Series	Product	Display				Interface				
		Display Size	Resolution	LCD	Color	Ethernet	Serial	CANopen (master)	USB (host)	USB (Device)
LT4000M Series 	LT-4301TM DIO model	5.7"	QVGA 320x240pixels	TFT	65,536	1	1 (RJ45)	1 (D-sub9)	1	1
	LT-4301TM Analog model									
	LT-4201TM DIO model	3.5"								
	LT-4201TM Analog model									
LT3000 Series 	LT-3300T	5.7"	QVGA 320x240pixels	TFT	65,536	1	1 (D-sub9)	-	1	-
	LT-3300L			Monochrome	16 Shades					
	LT-3301L			Monochrome	8 Shades					
	LT-3201A	Monochrome (Amber / Red)		8 Shades						



CANopen Networking

The LT4000M provides data exchange with various remote devices via CANopen for an economical and user-friendly system design. Choose between standard I/O modules or more sophisticated products such as motion or control for complex applications.

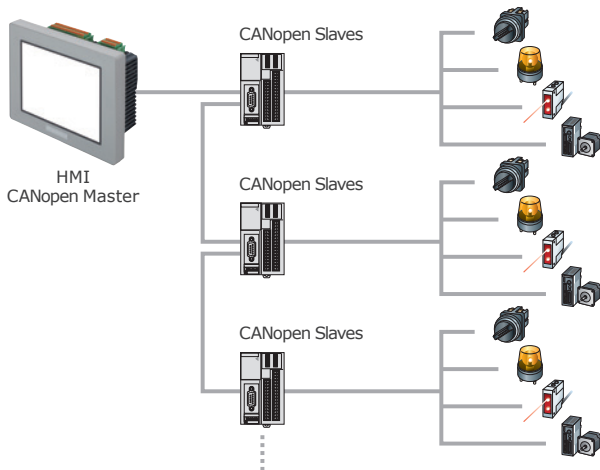

Pro-face Remote HMI

The natural link between the process and your tablet or smartphone. By adding the APP true mobile operation will be possible without loss of operability.

Confirm the cause of an error directly with your mobile device and see if the machine can be put back into operation without going on site.*

Pro-face Remote HMI

Remote Monitoring Software for mobile



* Supported from beginning of 2014.

Controller								
Built-in DIO		Built-in AIO		Special DIO		Expansion Unit		Controller Memory Size
Input	Output	Input	Output	Shared Use of Built-in DIO	Exclusive Use	EX Module	CANopen	
20	10	—	—	2 High-speed Counter (with Synchronize Output) Pulse Catch Input	2 Pulse Output PWM Output	—	63 Nodes	FLASH EPROM 132KB Equivalent to 15,000 Steps (Up to 60,000 Steps)
12	6	4	2					
20	10	—	—					
12	6	4	2					
16	16	—	—	4 High-speed Counter (with Synchronize Output) Pulse Catch Input Pulse Output PWM Output	—	3 Units Max. Up to 48 IOs	63 Nodes	FLASH EPROM 132KB Equivalent to 15,000 Steps (Up to 60,000 Steps)
12	6	—	—			2 Units Max. Up to 32 IOs		

Connect to a wide range of control equipment

Pro-face HMIs support connection with a wide range of industrial controllers including PLCs, motion controllers, robots, and other devices.

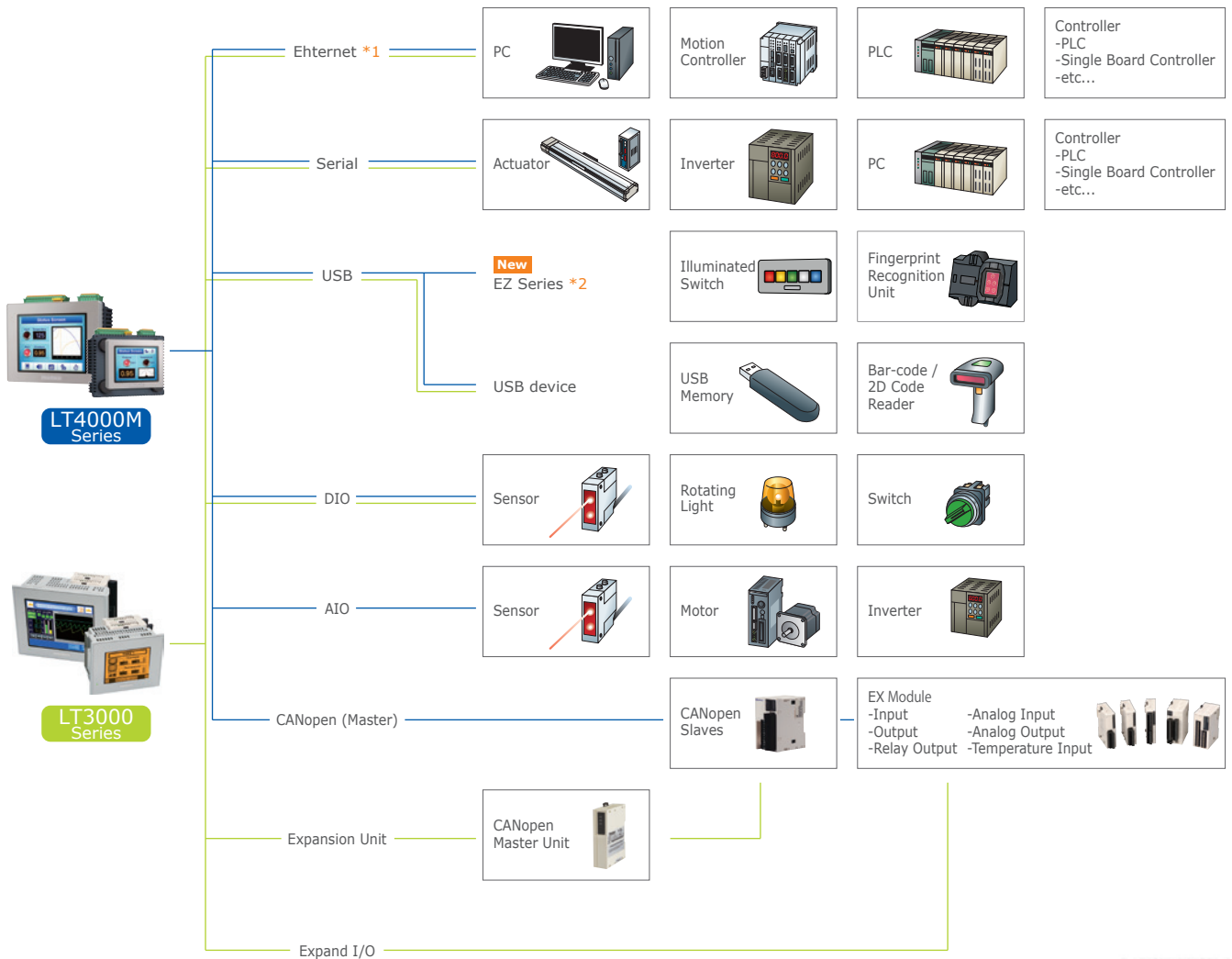

*1 Only for units with Ethernet.
 *2 Only for LT4000M Series.

For further information, visit our website.

<http://www.pro-face.com/product/soft/gpproex/driver/driver.html>



Remote Monitoring

LT4000M Series

LT3000 Series

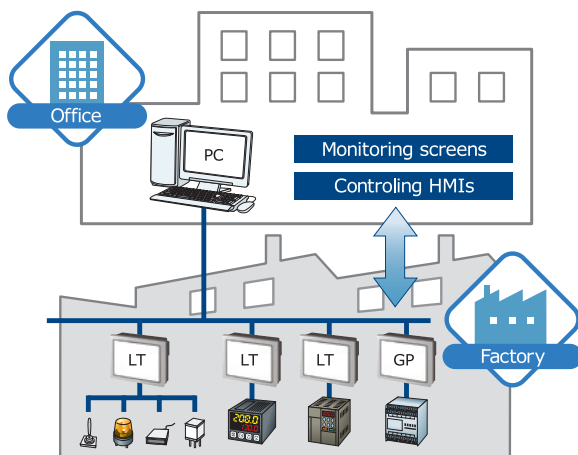

Use remote monitoring software, GP-Viewer* or data management software, Pro-Server EX* to easily monitor and control HMI screens on the production site, or distribute instruction data and collect real-time production data.

* Requires separate license.

GP-Pro EX



Improving development efficiency and maintaining technical know-how.

Screens and logic programs*1 can be edited with the same software*2, and the same addresses or user-defined control symbols can be shared for both screen parts and logic elements with drag-and-drop operation.

Controller addresses can be written directly to help reduce development time. Using the Function Block feature lets you reuse configured logic components and protect technical know-how via password protection.

*1 IEC 61131-3-compliant *2 LT4000M Series requires GP-Pro EX Ver.3.12 or later.

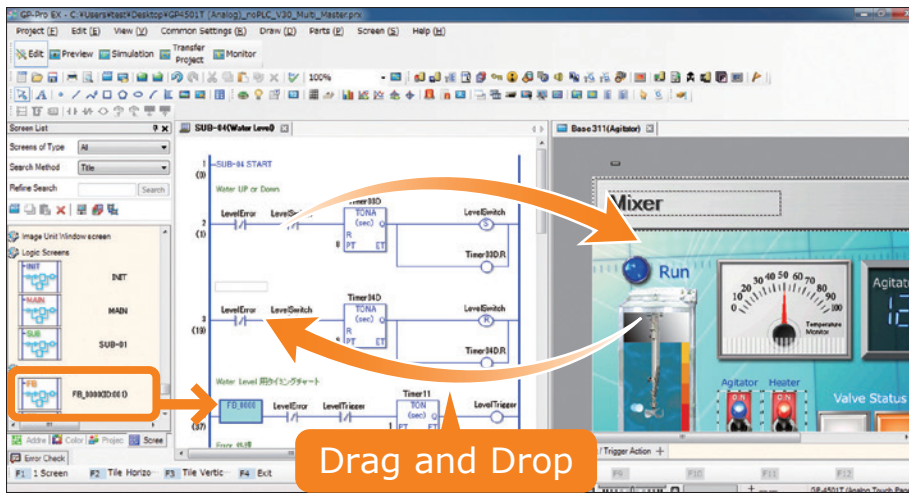
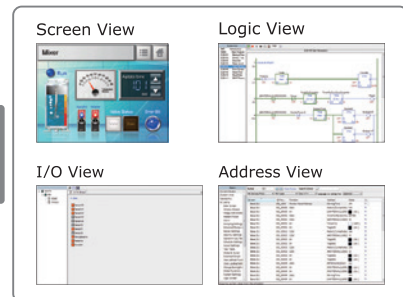

Image of Ladder Logic screen. Instruction List Logic screen also available.

Easily verify and debug projects with GP-Pro EX.

GP-Pro EX Simulation is an off-line simulation function which enables verification of screens, logic programs, and program operation without connecting to an HMI.



Logic Monitor function allows you to perform on-line logic program simulation on the HMI.

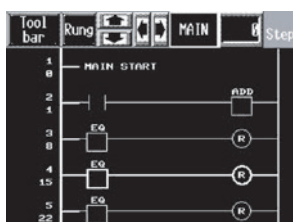

● Logic Monitor
Displays the whole ladder program. You can check the operation status and logic program.



● Address Monitor
Displays addresses used in the ladder program. Displays variables and their current values.

For further information, visit our website.
<http://www.pro-face.com/product/soft/gpproex.html>



Product Specifications Summary

LT4000M Series		LT3000 Series					
		LT-4301TM	LT-4201TM	LT-3300T	LT-3300L	LT-3301L	LT-3201A
Display Type	TFT			Monochrome		Monochrome Amber/Red	
Display Size	5.7"		3.5"		5.7"		3.8"
Resolution	320 x 240 pixels (QVGA)						
Display Colors	65,536 colors			Monochrome (16 Levels)		Monochrome (8 Levels)	
Brightness Control	-			8 Levels (Adjusted with the touch panel)			
Touch Panel Type	Resistive Film (analog)						
Application Memory *1	FLASH EPROM 16 MB			FLASH EPROM 6 MB			
Data Backup	nvSRAM 128 KB *2			SRAM 128 KB *2			
Control Memory	Variable Area	nvSRAM 64 KB *2			SRAM 64 KB *2		
	Program Area	FLASH EPROM 132 KB					
	Number of Step *3	Equivalent to 15,000 steps					
Interface	Serial (COM1)	RS-232C/485, Asynchronous Transmission, Data Length: 7 or 8 bit, Parity: none, Even or Odd, Stop Bit: 1 or 2 bit, Data Transmission Speed: 2,400 bps to 115.2 kbps, Connector: RJ45		RS-232C/422/485, Asynchronous Transmission, Data Length: 7 or 8 bit, Parity: none, Even or Odd, Stop Bit: 1 or 2 bit, Data Transmission Speed: 2,400 bps to 115.2 kbps, Connector: D-Sub9 (plug)		-	
	CANopen (Master)	CAN-CIA (ISO 11898-2:2002 part2), Connector: D-sub9 (plug)		-			
	Ethernet (LAN)	IEEE802.3i/IEEE802.3u, 10BASE-T/100BASE-TX, Connector: Modular jack (RJ-45)				-	
	USB (TYPE-A)	Conforms to USB2.0 (TYPE-A) x 1, Power Supply Voltage: DC 5 V ±5 %, Output Current: 500 mA or less, Communication Distance: 5 m (16.4 ft) or less		Conforms to USB1.1 (TYPE-A) x 1, Power Supply Voltage: DC 5 V ±5 %, Output Current: 500 mA or less, Communication Distance: 5 m (16.4 ft) or less			
	USB (mini B)	USB Mini B V2.0		-			
Number of connecting devices	4			1			
Built-in DIO	Input	20 or 12 *4		16		12	
	Output	10 or 6 *4		16		6	
Special DIO *5 (Shared Use)	Input	100KHz Max. High-speed Counter (with Synchronize Output), Pulse Catch Input					
	Output	65kHz Max. Pulse Output, 65kHz Max. PWM Output *9					
Special DIO *6 (Exclusive Use)	Output	50kHz Max. Pulse Output, 65kHz Max. PWM Output		-			
Built-in AIO	Input *7	0 or 2 *4		-			
	Temperature Input *8	0 or 2 *4		-			
	Output *7	0 or 2 *4		-			
EX Module interface *10	-		1 *11		1 *11		
AUX / Expansion Unit *10	-		1				
Rated Input Voltage	DC24V						

*1 Capacity available for user application. *2 Rechargeable lithium battery for data back up. *3 Up to 60,000 steps can be converted in software. However, this reduces internal memory capacity (for screen data) by 1 MB.
 *4 The number of Built-in digital and analog IOs differs between DIO type and Analog type. *5 Uses built-in DIO's points. *6 When using Pulse Output and PWM Output on LT4000M, External I/O and a LT unit must share the same power supply. *7 Various voltage and current input ranges are supported. *8 RTD: PT100, PT1000, NI100 and NI1000. Thermocouple: J, K, R, B, S, T, E and N.
 *9 For pulse outputs, when combining the number of CH and high-speed counters used, there is a limit to the maximum output frequency in the LT3000 Series. For details, please refer to GP-Pro EX Reference Manual.
 *10 EX Module and Communication Expansion Unit cannot be used at the same time. *11 Up to three (LT-330xx) or two (LT-3201A) EX modules can be connected.

External Dimensions / Panel Cut-Out

LT-4301TM

[External Dimensions/Interfaces]

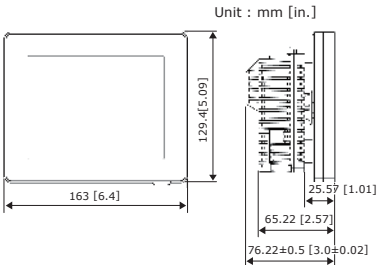

[Panel Cut-Out]

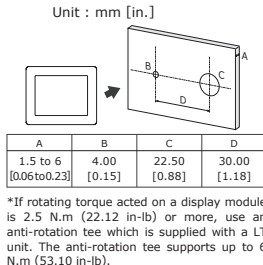

LT-4201TM

[External Dimensions/Interfaces]

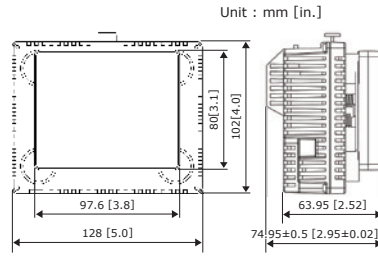

[Panel Cut-Out]

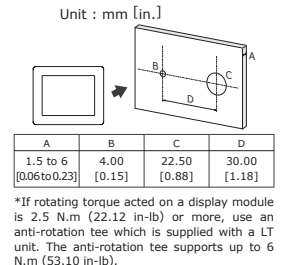

LT-3300T/L

[External Dimensions/Interfaces]

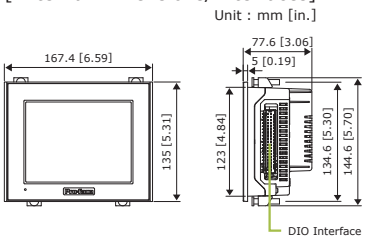

[Panel Cut-Out]

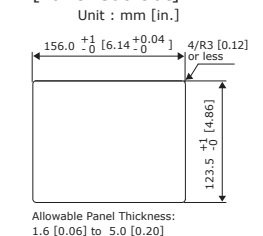

LT-3201A

[External Dimensions/Interfaces]

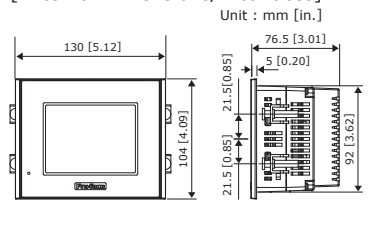

[Panel Cut-Out]

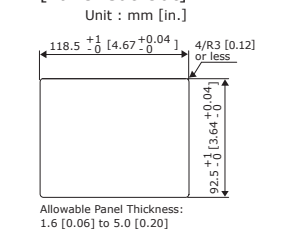

⚠ LT-3301L does not support Ethernet Interface.
The maximum thickness when three EX modules are connected: 123.0 mm [4.84 in.].

⚠ The maximum thickness when two EX modules are connected: 96.8 mm [3.81 in.].

Options

Software

" ** " is changed with the version of software.

Product Name	Global Code	Description	LT-4301TM	LT-4201TM	LT-330XX	LT-3201A
GP-Pro EX	PFXEXEDV**	HMI screen editor & logic programming software *1	○	○	○	○
GP-Pro EX Group License	PFXEXGRPLS****	GP-Pro EX Editor Group License *1 *2	○	○	○	○
GP-Pro EX Editor License	PFXEXEDLSV**	GP-Pro EX editor license *3 *4	○	○	○	○
GP-Viewer EX	1 licence	PFXEXVW	○	○	○	-
	10 licence	PFXEXVWLS10				
	30 licence	PFXEXVWLS30				
Pro-Server EX Developer	PFXEXSDV**	Software that connects a PC to a LT via Ethernet and collects and transmits data *4 *5	○	○	○	-
Pro-Server EX Developer License	PFXEXSDLS	Pro-Server EX developer license *4 *6	○	○	○	-
Pro-Server EX Runtime License	PFXEXSRLS	Pro-Server EX Runtime license *4 *7	○	○	○	-
MES Action License	PFXEXMSLSV**	License key permitting Pro-Server EX to access a database	○	○	○	-

*1 LT4000M Series requires GP-Pro EX Ver.3.12 or later. *2 Group License consists of one set of Serial No./Key Code for installation. (Should be used in the same office. Only supports GP-Pro EX Ver.3.1 or later.)

*3 Purchase this product when installing GP-Pro EX in a second or subsequent PC. One license is required for each PC. *4 Only for units with Ethernet. *5 Includes the settings editor and Run time.

*6 Purchase this product when installing the settings editor and Run time in subsequent PCs. *7 Purchase this license when installing only Run time in subsequent PCs. One license is required for each PC.

I/O Units (EX Module / CANopen unit)

Product Name	Global Code	Description	LT-4301TM	LT-4201TM	LT-330XX	LT-3201A
8-Point Input Module	PFXZLTEUDDI8DT	8-point sink-source shared expansion unit *8	○	○	○	○
8-Point Relay Output Module	PFXZLTEUDRA8RT	8-point relay output / 2-point common type expansion unit *8	○	○	○	○
8-Point Sink Output Module	PFXZLTEUDDO8UT	8-point transistor output sink type expansion unit *8	○	○	○	○
8-Point Source Output Module	PFXZLTEUDDO8TT	8-point transistor output source type expansion unit *8	○	○	○	○
16-Point Input Module	PFXZLTEUDDI16DT	16-point sink-source shared expansion unit *8	○	○	○	○
16-Point Relay Output Module	PFXZLTEUDRA16RT	16-point relay output / 2-point common type expansion unit *8	○	○	○	○
16-Point Sink Output Module	PFXZLTEUDDO16UK	16-point transistor output sink type expansion unit *8	○	○	○	○
16-Point Source Output Module	PFXZLTEUDDO16TK	16-point transistor output source type expansion unit *8	○	○	○	○
4-Point Input / 4-Point Relay Output Module	PFXZLTEUDDMM8DRT	4-point input sink-source / 4-point relay output / 1 common mixed I/O unit *8	○	○	○	○
2-ch Analog Input Module	PFXZLTEUAMI2HT	2-ch analog input type expansion unit *8	○	○	○	○
Thermocouple (Pt100 Input) / 1-ch Analog Output Module	PFXZLTEUALM3LT	2-ch temperature input / 1-ch analog output type expansion unit *8	○	○	○	○
2-ch Analog Input / 1-ch Analog Output Module	PFXZLTEUAMM3HT	2-ch analog input / 1-ch analog output expansion unit *8	○	○	○	○
1-ch Analog Output Module	PFXZLTEUAMO1HT	1-ch analog output type expansion unit *8	○	○	○	○
4-ch Voltage, Current, Pt100 / Pt1000 / Ni100 / Ni1000 Input Module	PFXZLTEUAMI4LT	4-ch Analog Input / Temperature Input Expansion Unit *8	○	○	○	○
2-ch Analog Output Module	PFXZLTEUAUO2HT	2-ch Analog output Expansion Unit *8	○	○	○	○
4-ch Analog Input / 2-ch Analog Output Module	PFXZLTEUAMM6HT	4-ch Analog Input / 2-ch Analog Output Expansion Unit *8	○	○	○	○
8-ch Temperature Pt100 / Pt1000 Input Module	PFXZLTEUARI8LT	8-ch Temperature Input Expansion Unit *8	○	○	○	○
16-point Input / 8-point Relay Output Module	PFXZLTEUDDMM24DRF	16-point Input Sink-Source / 8-Point Relay Output Expansion Unit *8	○	○	○	○
CANopen Master Unit	PFXZC8EUCA1	Master unit to connect to a slave unit supporting CANopen	-	-	○	○
CANopen Slave HTB Unit	PFXHTB1C0DM9LP	Slave unit supporting CANopen with 12 digital inputs, 6 relay outputs and 2 transistor source outputs. Up to 7 units of EX modules can be connected. *8	○	○	○	○

*8 LT4000M Series requires GP-Pro EX Ver.3.50 or later.

Cable, Adapter, and other options.

Product Name	Global Code	Description	LT-4301TM	LT-4201TM	LT-330XX	LT-3201A	
Cable	USB Transfer Cable (2m)	PFXZC3CBUSA1	USB cable for transferring data such as screen data (host to host)	○	○	○	○
	USB Transfer Cable (USB Type A/mini B)(1.8 m)	PFXZC9USECBMB1	Cable for transferring screen data from a PC (USB Type A) to the GP unit (USB mini B).	○	○	-	-
	USB Panel-mount Extension Cable (USB mini B)(1m)	PFXZC9USEXMB1	Extension cable attaching to the USB (mini B) interface on the front side of the operation panel.	○	○	-	-
	USB Cable (5m)	PFXZC0CBUS1	Connects a USB peripheral unit. (host to slave)The cable for extending the LT's USB port	○	○	○	○
	USB Front Cable (1m)	PFXZC5CBUBEX1	The conversion cable for using a LT's USB I/F as the Serial (RS-232C) I/F. Connects a Modem only for the RS-232C communication method.	○	○	○	○
	USB-Serial (RS-232C) Conversion Cable (50cm)	PFXZC6CBCVUSR21	Interface cable for communication between a temperature controller/ various boards and the LT series via RS-232C.	-	-	○	○
	RS-232C Cable (5m)	PFXZC3CBR251	Interface cable for communication between a temperature controller/ various boards and the LT series via RS-232C.	-	-	○	○
	RJ45 RS-232C Cable (5m)	PFXZLMCBJR21	Cable with loose wires at one end for RS-232C connection between various hosts and the LT.	○	○	-	-
	RJ45 RS-485 Cable (5m)	PFXZLMCBJR81	Cable with loose wires at one end for RS-485 connection between various hosts and the LT.	○	○	-	-
	RS-422 Cable (5m)	PFXZC3CBR452	Interface cable for communication between a temperature controller/ various boards and the LT series via RS-422.	-	-	○	○
	RS-422 Cable (5m)	PFXZC3CBR451	Interface cable for communication between a temperature controller/ various boards and the LT series via RS-422. <for a unit of terminal resistance 100>	-	-	○	○
	Display module/Rear module separation cable (3m)	PFXZXMADSM31	Cable with hook to install a rear module on a DIN rail while connecting the rear module to a separated display module	○	○	-	-
	Display module/Rear module separation cable (5m)	PFXZXMADSM51		○	○	-	-
EZ Series	EZ Illuminated Switch	PFXZCCEUSG1	A unit of 5 illuminated switches with multiple color LED easily connected with HMI via USB	○	○	-	-
	EZ Fingerprint Recognition Unit	PFXZCCEUSS1	Fingerprint recognition unit easily connected with HMI via USB *9	○	○	-	-
Adapter	COM port adapter	PFXZC3ADCM1	Pin assign conversion adapter connects optional RS-422 communication items to LT series unit's COM1 port.	-	-	○	○
	Terminal block conversion adapter	PFXZC3ADR41	Conversion adapter converts a COM port to RS-422 terminal block.	-	-	○	○
	RS-232C Isolation Unit	PFXZC3ADISR21	Unit for providing isolated connection between a temperature controller/ various boards and the LT series. RS-232C and RS-422 are switchable.	-	-	○	○
Screen Protection Sheet		PFXZC3DS61	Disposable, dirt-resistant sheet for the LT unit's screen (5 pcs/set)	-	-	○	○
		PFXZC6DS41		-	○	-	-
		PFXZC6DS61		-	○	-	-
Environmentally-resistant Cover	PFXZC4CNDCM1	Regarding grease and chemical application, do not remove the unit, simply replace the environmental protection cover (5 pcs/set)	-	-	○	-	
Panel Cutout Adapter	PFXZC4AT61	Attachment required for installing a 5.7-inch display unit in the mounting hole of LT Series (GLC150).	-	-	○	-	

*9 EZ Fingerprint Recognition Unit involves fingerprint technology. In some jurisdictions, this product may be subject to notification to and/or approval by relevant local regulatory authority prior to importing this product into such jurisdictions and/or using this product in such jurisdictions. The jurisdictions which do not require such notification and/or approval as of December 1,2012 ("Non-regulated Jurisdictions") are as follows: Japan, Taiwan, USA, Canada, Mexico, Brazil, Australia and Singapore.

Maintenance Options

For list of the maintenance options, if a product is damaged or lost, please visit our website.

For further information, visit our website.

http://www.pro-face.com/product/hmi/lt4000m/option/option_other.html





LT-4301TM

Model : PFXLM4301TADDK
PFXLM4301TADDC
PFXLM4301TADAK
PFXLM4301TADAC



Notice to our valued customers who use LT4000M series (analog model) :
You may experience instances when analog signals are output while the LT4000M is starting up.
Measures :
External equipment connected to analog output terminals should be design so powering up occurs only after the LT4000M has started up.
Considering the above, if the LT4000M and external equipment have different power supplies, please design your system with momentary power interruptions in mind.

Model Name Indication

PFXLM4301TAD**											
(1)	(2)	(3)	(4)	(5)	(6)	(1)	(2)	(3)	(4)	(5)	(6)
3	5.7 in.	T	TFT Color LCD	A	Analog Touch Panel	D	DC24V				
						(5)			(6)		
						D	Digital I/O	K	Sink Output Type		
						A	Analog I/O and Digital I/O	C	Source Output Type		

Display Specifications

		LT-4301TM		
		DIO	AIO and DIO	
Models		PFXLM4301TADDK : Sink Output Type PFXLM4301TADDC : Source Output Type	PFXLM4301TADAK : Sink Output Type PFXLM4301TADAC : Source Output Type	
Type		TFT Color LCD		
Resolution (pixels)		320 x 240 (QVGA)		
Active display area (W x H)		115.2 x 86.4 mm (4.53 x 3.40 in.)		
Display Colors		65,536 colors		
Backlight		White LED Non-exchangeable		
Brightness adjustment		LED ON / OFF control, adjustable screen saver activation time 16 levels of adjustment available via touch panel in the configuration menu		
Language Fonts *1		Japanese, ASCII, Chinese (Simplified), Chinese (Traditional), Korean, Cyrillic, Thai		
Character sizes		8 x 8, 8 x 16, 16 x 16 and 32 x 32 pixel fonts		
Font sizes		Width can be expanded 1 to 8 times. Height can be expanded 1/2 and 1 to 8 times.		
8 x 8 pixels		40 characters per row x 30 rows		
8 x 16 pixels		40 characters per row x 15 rows		
16 x 16 pixels		20 characters per row x 15 rows		
32 x 32 pixels		10 characters per row x 7 rows		
Memory	Application memory *2	FLASH EPROM 16 MB (includes screen editing program and extended logic program)		
	Logic program area	FLASH EPROM 132 KB *3 (equivalent to 15,000 steps)		
	Font area	FLASH EPROM 8 MB (when limit exceeded, uses application memory)		
	Data backup	nvSRAM 128 KB (rechargeable lithium battery for data backup)		
	Variable area	nvSRAM 64 KB (rechargeable lithium battery for data backup)		
Touch Panel	Type	Resistive Film (analog)		
	Lifetime	1 million touches or more		
Interface	Serial (COM1)	RS-232C (Connector type: RJ45, Isolation: None, Maximum baud rate: 115,200 bps, Cable Type: Shielded, Cable Maximum length: 15 m (49 ft), 5 Vdc power supply for RS-232C: None) RS-485 (Connector type: RJ45, Isolation: None, Maximum baud rate: 115,200 bps, Cable Type: Shielded, Cable Maximum length: 200 m (656 ft), Polarization: Setting is required via software when connecting Multiple LTs. Refer to the "GP-Pro EX Device/ PLC Manual" for the setting. 5 Vdc power supply for RS-485: None) *4		
	CANopen (master)	CAN-CiA (ISO 11898-2:2002 Part 2), Connector: D-sub9 (pin)		
	Ethernet	IEEE802.3 compliant Ethernet x 1 (Connector type: RJ45, Driver: 10 M half duplex (auto negotiation)/ 100 M full duplex (auto negotiation), Cable type: Shielded, Automatic cross-over detection: Yes)		
	USB (Type A)	USB 2.0 (Type A) x 1 (Power Supply Voltage: 5Vdc +/-5%, Maximum Current Supplied: 500mA, Maximum Transmission Distance: 5m (16.4 ft.))		
	USB (mini B)	USB 2.0 (Mini-B) x 1		
	Control	DIO (Sink Type)	20 Points Standard Input (including 2 Points for Fast Input) 10 Points Standard Output, 2 Points for Fast Output	12 Points Standard Input (including 2 Points for Fast Input) 6 Points Standard Output and 2 Points Fast Output
		DIO (Source Type)	20 Points Standard Input (including 2 Points for Fast Input) 10 Points Standard Output and 2 Points Fast Output	12 Points Standard Input (including 2 Points for Fast Input) 6 Points Standard Output and 2 Points Fast Output
AIO		—	2 ch analog inputs (13-bit) and 2 ch analog inputs (16-bit) for Thermocouple 2 ch analog outputs (12-bit)	

*1: Please refer to the GP-Pro EX Reference Manual for details on font types and character codes.
*2: Capacity available for user application.
*3: Up to 60,000 steps can be converted in software. However, this reduces application memory capacity (for screen data) by 1 MB.
*4: 2-wire connection is available for RS-485. When a Device/PLC supports 2-wire connection, 4 wires (RXD+, TXD+, RXD-, and TXD-) can be short-circuited to be 2 wires (RXD+ and TXD+ = D1, RXD- and TXD- = D0). For details on the connection, refer to the connection manual.

General Specifications

		LT-4301TM	
		DIO	AIO and DIO
Supported Standards and Regulations			
Rated Input Voltage	24 Vdc		
Input Voltage Limits	20 to 28.8 Vd		
Acceptable Voltage Drop	10 ms or less at 20.4 Vdc		
Power Consumption	10 W or less	13 W or less	
In-Rush Current	30 A or less at 28.8 Vdc		
Voltage Endurance between power terminal and frame ground (FG)	500 Vdc for 1 minute		
Insulation Resistance between power terminal and FG	10 MΩ or higher at 500 Vdc		

Environmental Specifications

		LT-4301TM	
		DIO	AIO and DIO
Standard compliance		IEC61131-2	
Ambient operating temperature for the display and the rear module	Horizontal installation	0 to 50°C (32 to 122°F)	
	Vertical installation	0 to 40°C (32 to 104°F)	
Storage temperature		- 20 to 60°C (- 4 to 140°F)	
Storage altitude		0 to 10,000 m (0 to 32,808 ft)	
Operating altitude		0 to 2,000 m (0 to 6,560 ft)	
Surrounding Air and Storage Humidity		5 to 85% w/o condensation (non-condensing, wet bulb temperature 39°C (102.2°F) or less)	
Degree of pollution	IEC60664	2	
Degree of protection	IEC61131-2	IP20 with protective covers in place	
Corrosive gases		Free of corrosive gases	
Dust		≤0.1 mg/m ³ (10 ⁻⁷ oz/ft ³) (non-conductive levels)	
Atmospheric pressure (Operating Altitude)		800 to 1,114 hPa (2000 m (6,561 ft) or lower)	
Vibration resistance	Mounted on a DIN rail	3.5 mm (0.138 in.) fixed amplitude from 5 to 8.4 Hz 9.8 m/s ² (1 gn) fixed acceleration from 8.4 to 150 Hz	
	Mounted on a panel	3.5 mm (0.138 in.) fixed amplitude from 5 to 8.6 Hz 9.8 m/s ² (1 gn) fixed acceleration from 8.6 to 150 Hz	
Mechanical shock resistance	Mounted on a DIN rail	147 m/s ² (15 gn) for a duration of 11 ms	
	Mounted on a panel	147 m/s ² (15 gn) for a duration of 6 ms	
Electrostatic discharge	IEC/EN61000-4-2	8 kV (air discharge) 6 kV (contact discharge)	
Radiated radio frequency electromagnetic fields	IEC/EN61000-4-3	10 V/m (80 MHz to 3 GHz)	
Fast transients / Burst noise	IEC/EN61000-4-4	Power lines: 2 kV Digital I/O: 1 kV Relay outputs: 2 kV Ethernet line: 1 kV COM line: 1 kV CAN line: 1 kV	
Surge immunity	IEC/EN61000-4-5	Power supply: CM: 1 kV; DM: 0.5 kV Digital I/O: CM: 1 kV; DM: 0.5 kV Shielded cable: 1 kV CM = line-earth DM = line-line	
Conducted disturbances induced by radio-frequency fields	IEC/EN61000-4-6	10 Veff (0.15 to 80 MHz)	
Mains terminal disturbance voltage	EN55011 (IEC/CISPR11)	150 to 500 kHz, quasi peak 79 dBμV	
		500 kHz to 30 MHz, quasi peak 73 dBμV	
Electric field strength	EN55011 (IEC/CISPR11)	30 to 230 MHz, quasi peak 10 m @40 dBμV/m	
		230 MHz to 1 GHz, quasi peak 10 m @47 dBμV/m	
Vibration immunity (operating)		IEC61131-2	
Protection structure		NEMA TYPE 4X (Indoors, with panel embedded)	
Protection (front module)		IP65f - (IEC60529)	
Protection (rear module)		IP20 - (IEC60529)	
Shock immunity (operating)		IEC61131-2 15gn 11ms	
Cooling method		Natural air circulation	
Weight		749 g (26.41 oz)	784 g (27.65 oz)
Color		Front module: PT404 Rear module: RAL 7032	
Material		Front module: PAA+GF Rear module: PC/PBT	

Digital Input Characteristics

		LT-4301TM
Rated Current		5 mA
Inrush Values	Voltage	30 Vdc
	Current	6.29 mA max.
Input impedance		4.9 kΩ
Input type		Sink/Source
Rated voltage		24 Vdc
Maximum Allowable Voltage		28.8 Vdc
Input limit values	ON Voltage	15 Vdc or more (15 to 28.8 Vdc)
	OFF Voltage	5 Vdc or less (0 to 5 Vdc)
	ON Current	2.5 mA or more
	OFF Current	1.0 mA or less
Isolation	Method	Photocoupler Isolation
	Between internal logic	500 Vdc
Filtering		0.5 ms x N (N is 0 to 63)
IEC61131-2 edition 3 type		Type 1
Compatibility		Supports 2 wire and 3 wire sensors
Cable type and length		Shielded: Maximum 100 m (328 ft) Non-shielded: 50 m (164 ft)
Terminal blocks		Type: 3.5 mm (0.137 in.) pitch Terminal blocks are removable
Input paralleling		No

High Speed Counter Input Characteristics

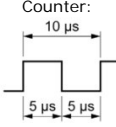
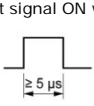
		LT-4301TM
Rated Current	Voltage	24 Vdc
	Current	7.83 mA
Inrush values	Voltage	30 Vdc
	Current	9.99 mA
Input impedance		3.2 kΩ
Input type		Sink/Source
Rated voltage		24 Vdc
Maximum Allowable Voltage		28.8 Vdc
Input limit values	ON Voltage	15 Vdc or more
	OFF Voltage	5 Vdc or less
	ON Current	5 mA or more
	OFF Current	1.5 mA or less
Isolation	Method	Photo coupler Isolation
	Between channels logic	500 Vdc
Filtering		None, 4 μs, 40 μs
IEC61131-2 edition 3 type		Type 1
Compatibility		Supports 2 wire and 3 wire sensors
Cable	Type	Shielded
	Length	Maximum 10 m (33 ft)
Terminal blocks		Type: 3.5 mm (0.137 in.) pitch Terminal blocks are removable
Maximum frequency		<ul style="list-style-type: none"> 100 kHz is the maximum frequency for Single-phase 50 kHz is the maximum frequency for 2-phase Duty Rate: 45 to 55%
Phase Counting Mode		<ul style="list-style-type: none"> Single phase 2 Phase x2 2 Phase x4 2 Phase x2 Reverse 2 Phase x4 Reverse
Response time	Marker	1 ms
	Preload	1 ms
	Prestrobes	1 ms
	Synchronize output	2 ms
Min. Pulse Width(Pulse input)		<div style="display: flex; justify-content: space-around;"> <div style="text-align: center;"> <p>Counter:</p>  </div> <div style="text-align: center;"> <p>Pulse Catch Input signal ON width</p>  </div> </div>
Input paralleling		No

Transistor Output Characteristics

		LT-4301TM
Rated Voltage		24Vdc
Output range		19.2 to 28.8 Vdc
Output type		Sink/Source
Rated current		DIO: 0.3 A/point, 3.0 A/common AIO and DIO: 0.3 A/point, 1.8 A/common
Residual voltage		1.5 Vdc or less for I = 0.1A
Delay		Off to on (0.3 A load): 1.1ms On to off (0.3 A load): 2ms NOTE: The delay is not including the cable delay.
Isolation	Method	Photocoupler Isolation
	Between internal logic	500 Vdc
Minimum resistor load		80 Ω at 24 Vdc
Cable length		Non-shielded: 150 m (492 ft)
Protection against short circuit		No
Terminal blocks		Type: 3.5 mm (0.137 in.) pitch Terminal blocks are removable

NOTE: Refer to LT4201TM/4301TM Hardware Manual about Protecting Outputs from Inductive Load Damage for additional information on this topic.

Pulse Output/PWM Output/High-speed Counter (Synchronize Output) Characteristics

		LT-4301TM	
Output type		Sink/Source	
Rated voltage		24 Vdc	
Power supply input range		19.2 to 28.8 Vdc	
Power supply reverse protection		Yes	
Pulse Output/PWM output current		50 mA/point, 100 mA/common	
Response time for original input		2 ms	
Isolation resistance	Between fast outputs and internal logic	10 MΩ or more	
	Between power supply port and protective earth ground (PE) = 500 Vdc	10 MΩ or more	
Residual voltage	for I = 0, 1 A	1.5 Vdc or less	
Delay		Off to on (50 mA load): 1.1ms On to off (50 mA load): 1.1ms NOTE: The delay is not including the cable delay.	
Minimum load impedance		80 Ω	
Maximum Pulse output frequency		50 KHz	
Maximum Pulse output frequency		65 kHz	
Accuracy Pulse Output/ PWM Output	Frequency	Accuracy	Duty
	10~100Hz	0.1%	0 to 100%
	101~1000Hz	1%	1 to 99%
	1.001~20kHz	5%	5 to 95%
	20.001~45kHz	10%	10 to 90%
45.001~65kHz	15%	15 to 85%	
Duty rate range		1 to 99%	
Cable	Type	Shielded, including 24 Vdc power supply	
	Length	Maximum 5 m (16 ft)	
Terminal blocks		Type: 3.5 mm (0.137 in.) pitch Terminal blocks are removable	

NOTE: When using the acceleration/deceleration pulse output, there is a 1% maximum error for the frequency.

Analog Input Characteristics

		LT-4301TM	
		AIO and DIO	
Characteristics		Voltage input	Current input
Number of maximum input		2	
Input type		Single-ended	
Input range		-10 to 10 Vdc/0 to 10 Vdc	0 to 20 mA/4 to 20 mA
Input impedance		1 M Ω or more	250 \pm 0.11% Ω
Sample duration time		10 ms per channel + 1 scan time	
Total input system transfer time		20 ms + 1 scan time	
Input tolerance	Maximum deviation at 25°C (77°F) without electromagnetic disturbance	\pm 1% of the full scale	
	Maximum deviation	\pm 2.5% of the full scale	
Digital resolution		13 bits	
Temperature drift		\pm 0.06% of the full scale	
Common mode characteristics		80 db	
Cross talk		60 db	
Non-linearity		\pm 0.4% of full scale	
Input value of LSB		5 mV	10 μ A
Maximum allowed overload (no damages)		\pm 30 Vdc (less than 5 minutes) \pm 15 Vdc (No damage)	\pm 30 mA dc
Protection type		Photo coupler between input and internal circuit	
Cable	Type	Shielded	
	Length	Must be less than 3 m for IEC61131-2 conformance. Maximum transmission distance is 10m.	
Terminal blocks		Type: 3.5 mm (0.137 in.) pitch Terminal blocks are removable	
Isolation	External input	Photo-coupler isolation	
	Between channels	Non-isolated	

Temperature Input (Temperature Probes) Characteristics

		LT-4301TM	
		AIO and DIO	
Input sensor type		Pt100/Pt1000/Ni100/Ni1000	
Input temperature range		Pt100/Pt1000: -200 to 600°C (-328 to 1112°F) Ni100/Ni1000: -20 to 200°C (-4 to 392°F)	
Measuring current	Pt100/Ni100	1.12 mA \pm 3.5%	
	Pt1000/Ni1000	0.242 μ A \pm 3.5%	
Input impedance		Typically 10 M Ω	
Sample duration time		10 ms+1 cycle time	
Wiring type		2-wire or 3-wire connection configured by software for all inputs	
Conversion mode		Sigma delta type	
Input filter		Low pass	
Resolution temperature value		0.1°C (0.18°F)	
Detection type		Open circuit (detection on each channel)	
Input tolerance *1	Maximum deviation at 25°C (77°F) without electromagnetic disturbance	\pm 5°C (41°F)	
	Maximum deviation at 25 to 50°C (77 to 122°F)	Pt type: \pm 5.6°C (42.08°F) Ni type: \pm 5.2°C (41.36°F)	
Temperature drift		30 ppm/°C	
Digital resolution		16 bits	
Rejection in differential mode	50/60 Hz	Typically 60 dB	
Common mode rejection		Typically 80 dB	
Isolation Method		Photocoupler Isolation	
Permitted input signal		\pm 5 Vdc max.	
Cable length	Pt100/Ni100	200 Ω 以下	
	Pt1000/Ni1000	200 Ω 以下	
Terminal blocks		Type: 3.5 mm (0.137 in.) pitch Terminal blocks are removable	
Noise resistance - cable		Shielded cable is necessary	

* 1: Excluding errors caused by the wiring

Temperature Input (Thermocouple) Characteristics

		LT-4301TM
		AIO and DIO
Input sensor type		Thermocouple
Input type range *1		J (-200 to 760°C) (-328 to 1400°F) K (-240 to 1370°C) (-400 to 2498°F) R (0 to 1600°C) (32 to 2912°F) B (200 to 1800°C) (392 to 3272°F) S (0°C to 1600°C) (32 to 2912°F) T (-200 to 400°C) (-328 to 752°F) E (-200 to 900°C) (-328 to 1652°F) N (-200 to 1300°C) (-328 to 2372°F)
Input impedance		Typically 10 MΩ
Sample duration time		10 ms+1 cycle time
Conversion mode		Sigma delta type
Digital resolution		16 bits
Input filter		Low pass
Resolution temperature value		0.1°C (0.18°F) (Type J)
Detection type		Open circuit (detection on each channel)
Input tolerance	Maximum deviation at 25°C (77°F) without electromagnetic disturbance	0.2 % of the full scale, plus standard point of compensation precision at +/- 6°C.
	Maximum deviation	0.28 % of full scale range
Temperature drift		30 ppm/°C
Input tolerance - terminal temperature compensation		± 5°C (41°F) after 10 min.
Cold junction compensation in the temperature range (0 to 50°C (122°F))		Internal cold junction error: +/- 6°C (42.8°F) after operating 45 minutes.
Rejection in differential mode	50/60Hz	Typically 60 dB
Common mode rejection		Typically 80 dB
Isolation Method		Photocoupler Isolation
Permitted input signal		± 5 Vdc max.
Warm up time		45 minutes
Terminal blocks		Type: 3.5 mm (0.137 in.) pitch Terminal blocks are removable
Noise resistance - cable		Shielded cable is necessary

*1: Temperature measurement on PCB at terminal block for cold junction compensation.

Analog Output Characteristics

		LT-4301TM	
		AIO and DIO	
Characteristics		Voltage Output	Current Output
Maximum number of outputs		2	
Output range		-10 to 10 Vdc/0 to 10 Vdc	0 to 20 mA / 4 to 20 mA
Load impedance		2 kΩ or more	300 Ω or more
Application load type		Resistive load	
Setting time		10 ms	
Total output system transfer time		10 ms + 1 scan time	
Output tolerance	Maximum deviation at 25°C (77°F) without electromagnetic disturbance	± 1% of the full scale	
	Maximum deviation	± 2.5% of the full scale	
Digital resolution		12 bits	
Temperature drift		± 0.06% of the full scale	
Output ripple		±50mV	
Cross talk		60 db	
Non-linearity		± 0.5% of full scale	
Output value of LSB		6 mV	12 μA
Protection type		Photo coupler between input and internal circuit	
Output protection		Short circuit protection: Yes Open circuit protection: Yes	
Output behavior if input power supply is less than the power failed threshold		Set to 0	
Cable	Type	Shielded	
	Length	Must be less than 3 m for IEC61131-2 conformance. Maximum transmission distance is 10m.	
Terminal blocks		Type: 3.5 mm (0.137 in.) pitch Terminal blocks are removable	
Isolation	External input	Photo-coupler isolation	
	Between channels	Non-isolated	

External Dimensions/ Panel Cut-out

3.5 Inches Display Module
 <External Dimensions>

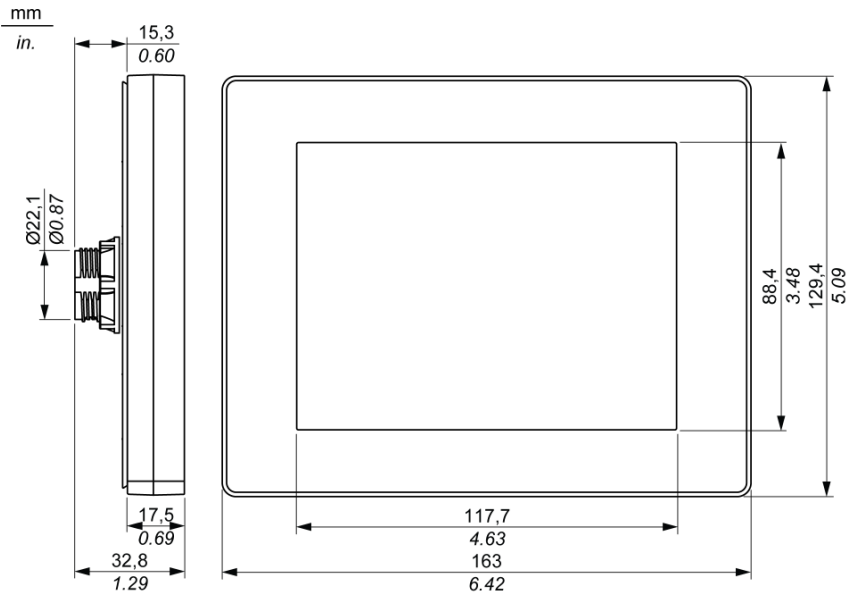

<Panel Cut-out>

mm
in.

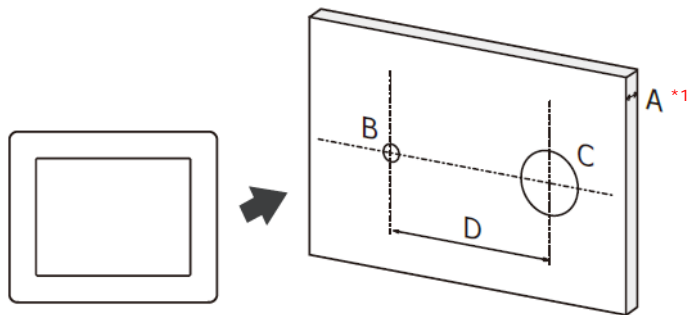

A	B	C	D
1.5 to 6	4.00	22.50	30.00
[0.06 to 0.23]	[0.15]	[0.88]	[1.18]

*1 If rotating torque acted on a display module is 2.5 N.m (22.12 in-lb) or more, use an anti-rotation tee which is supplied with a LT unit. The anti-rotation tee supports up to 6 N.m (53.10 in-lb).



LT-4201TM

Model : PFXLM4201TADDK
PFXLM4201TADDC
PFXLM4201TADAK
PFXLM4201TADAC



Model Name Indication

Notice to our valued customers who use LT4000M series (analog model) :
You may experience instances when analog signals are output while the LT4000M is starting up.
Measures :
External equipment connected to analog output terminals should be design so powering up occurs only after the LT4000M has started up.
Considering the above, if the LT4000M and external equipment have different power supplies, please design your system with momentary power interruptions in mind.

PFXLM4201TAD * *
(1) (2) (3) (4) (5) (6)

(1)	(2)	(3)	(4)
2	3.5 in.	T	TFT Color LCD
A	Analog Touch Panel	D	DC24V
(5)	(6)		
D	Digital I/O	K	Sink Output Type
A	Analog I/O and Digital I/O	C	Source Output Type

Display Specifications

		LT-4201TM	
		DIO	AIO and DIO
Models		PFXLM4201TADDK : Sink Output Type PFXLM4201TADDC : Source Output Type	PFXLM4201TADAK : Sink Output Type PFXLM4201TADAC : Source Output Type
Type		TFT Color LCD	
Resolution (pixels)		320 x 240 (QVGA)	
Active display area (W x H)		70.56 x 52.92 mm (2.78 x 2.08 in.)	
Display Colors		65,536 colors	
Backlight		White LED Non-exchangeable	
Brightness adjustment		LED ON / OFF control, adjustable screen saver activation time	
Language Fonts *1		16 levels of adjustment available via touch panel in the configuration menu Japanese, ASCII, Chinese (Simplified), Chinese (Traditional), Korean, Cyrillic, Thai	
Character sizes		8 x 8, 8 x 16, 16 x 16 and 32 x 32 pixel fonts	
Font sizes		Width can be expanded 1 to 8 times. Height can be expanded 1/2 and 1 to 8 times.	
8 x 8 pixels		40 characters per row x 30 rows	
8 x 16 pixels		40 characters per row x 15 rows	
16 x 16 pixels		20 characters per row x 15 rows	
32 x 32 pixels		10 characters per row x 7 rows	
Memory	Application memory *2	FLASH EPROM 16 MB (includes screen editing program and extended logic program)	
	Logic program area	FLASH EPROM 132 KB *3 (equivalent to 15,000 steps)	
	Font area	FLASH EPROM 8 MB (when limit exceeded, uses application memory)	
	Data backup	nvSRAM 128 KB (rechargeable lithium battery for data backup)	
	Variable area	nvSRAM 64 KB (rechargeable lithium battery for data backup)	
Touch Panel	Type	Resistive Film (analog)	
	Lifetime	1 million touches or more	
Interface	Serial (COM1)	RS-232C (Connector type: RJ45, Isolation: None, Maximum baud rate: 115,200 bps, Cable Type: Shielded, Cable Maximum length: 15 m (49 ft), 5 Vdc power supply for RS-232C: None) RS-485 (Connector type: RJ45, Isolation: None, Maximum baud rate: 115,200 bps, Cable Type: Shielded, Cable Maximum length: 200 m (656 ft), Polarization: Setting is required via software when connecting Multiple LTs. Refer to the "GP-Pro EX Device/ PLC Manual" for the setting. 5 Vdc power supply for RS-485: None) *4	
	CANopen (master)	CAN-CiA (ISO 11898-2:2002 Part 2), Connector: D-sub9 (pin)	
	Ethernet	IEEE802.3 compliant Ethernet x 1 (Connector type: RJ45, Driver: 10 M half duplex (auto negotiation)/ 100 M full duplex (auto negotiation), Cable type: Shielded, Automatic cross-over detection: Yes)	
	USB (Type A)	USB 2.0 (Type A) x 1 (Power Supply Voltage: 5Vdc +/-5%, Maximum Current Supplied: 500mA, Maximum Transmission Distance: 5m (16.4 ft.))	
	USB (mini B)	USB 2.0 (Mini-B) x 1	
	Control	DIO (Sink Type)	20 Points Standard Input (including 2 Points for Fast Input) 10 Points Standard Output, 2 Points for Fast Output
DIO (Source Type)		20 Points Standard Input (including 2 Points for Fast Input) 10 Points Standard Output and 2 Points Fast Output	12 Points Standard Input (including 2 Points for Fast Input) 6 Points Standard Output and 2 Points Fast Output
AIO		—	2 ch analog inputs (13-bit) and 2 ch analog inputs (16-bit) for Thermocouple 2 ch analog outputs (12-bit)

*1: Please refer to the GP-Pro EX Reference Manual for details on font types and character codes.

*2: Capacity available for user application.

*3: Up to 60,000 steps can be converted in software. However, this reduces application memory capacity (for screen data) by 1 MB.

*4: 2-wire connection is available for RS-485. When a Device/PLC supports 2-wire connection, 4 wires (RXD+, TXD+, RXD-, and TXD-) can be short-circuited to be 2 wires (RXD+ and TXD+ = D1, RXD- and TXD- = D0). For details on the connection, refer to the connection manual.

General Specifications

		LT-4201TM	
		DIO	AIO and DIO
Supported Standards and Regulations			
Rated Input Voltage		24 Vdc	
Input Voltage Limits		20 to 28.8 Vd	
Acceptable Voltage Drop		10 ms or less at 20.4 Vdc	
Power Consumption		9 W or less	12 W or less
In-Rush Current		30 A or less at 28.8 Vdc	
Voltage Endurance between power terminal and frame ground (FG)		500 Vdc for 1 minute	
Insulation Resistance between power terminal and FG		10 MΩ or higher at 500 Vdc	

Environmental Specifications

		LT-4201TM	
		DIO	AIO and DIO
Standard compliance		IEC61131-2	
Ambient operating temperature for the display and the rear module	Horizontal installation	0 to 50°C (32 to 122°F)	
	Vertical installation	0 to 40°C (32 to 104°F)	
Storage temperature		- 20 to 60°C (- 4 to 140°F)	
Storage altitude		0 to 10,000 m (0 to 32,808 ft)	
Operating altitude		0 to 2,000 m (0 to 6,560 ft)	
Surrounding Air and Storage Humidity		5 to 85% w/o condensation (non-condensing, wet bulb temperature 39°C (102.2°F) or less)	
Degree of pollution	IEC60664	2	
Degree of protection	IEC61131-2	IP20 with protective covers in place	
Corrosive gases		Free of corrosive gases	
Dust		≤0.1 mg/m ³ (10 ⁻⁷ oz/ft ³) (non-conductive levels)	
Atmospheric pressure (Operating Altitude)		800 to 1,114 hPa (2000 m (6,561 ft) or lower)	
Vibration resistance	Mounted on a DIN rail	3.5 mm (0.138 in.) fixed amplitude from 5 to 8.4 Hz 9.8 m/s ² (1 gn) fixed acceleration from 8.4 to 150 Hz	
	Mounted on a panel	3.5 mm (0.138 in.) fixed amplitude from 5 to 8.6 Hz 9.8 m/s ² (1 gn) fixed acceleration from 8.6 to 150 Hz	
Mechanical shock resistance	Mounted on a DIN rail	147 m/s ² (15 gn) for a duration of 11 ms	
	Mounted on a panel	147 m/s ² (15 gn) for a duration of 6 ms	
Electrostatic discharge	IEC/EN61000-4-2	8 kV (air discharge) 6 kV (contact discharge)	
Radiated radio frequency electromagnetic fields	IEC/EN61000-4-3	10 V/m (80 MHz to 3 GHz)	
Fast transients / Burst noise	IEC/EN61000-4-4	Power lines: 2 kV Digital I/O: 1 kV Relay outputs: 2 kV Ethernet line: 1 kV COM line: 1 kV CAN line: 1 kV	
Surge immunity	IEC/EN61000-4-5	Power supply: CM: 1 kV; DM: 0.5 kV Digital I/O: CM: 1 kV; DM: 0.5 kV Shielded cable: 1 kV CM = line-earth DM = line-line	
Conducted disturbances induced by radio-frequency fields	IEC/EN61000-4-6	10 Veff (0.15 to 80 MHz)	
Mains terminal disturbance voltage	EN55011 (IEC/CISPR11)	150 to 500 kHz, quasi peak 79 dBμV	
		500 kHz to 30 MHz, quasi peak 73 dBμV	
Electric field strength	EN55011 (IEC/CISPR11)	30 to 230 MHz, quasi peak 10 m @40 dBμV/m	
		230 MHz to 1 GHz, quasi peak 10 m @47 dBμV/m	
Vibration immunity (operating)		IEC61131-2	
Protection structure		NEMA TYPE 4X (Indoors, with panel embedded)	
Protection (front module)		IP65f - (IEC60529)	
Protection (rear module)		IP20 - (IEC60529)	
Shock immunity (operating)		IEC61131-2 15gn 11ms	
Cooling method		Natural air circulation	
Weight		496 g (17.49 oz)	531g (18.73 oz)
Color		Front module: PT404 Rear module: RAL 7032	
Material		Front module: PC/PBT Rear module: PC/PBT	

Digital Input Characteristics

		LT-4201TM
Rated Current		5 mA
Inrush Values	Voltage	30 Vdc
	Current	6.29 mA max.
Input impedance		4.9 kΩ
Input type		Sink/Source
Rated voltage		24 Vdc
Maximum Allowable Voltage		28.8 Vdc
Input limit values	ON Voltage	15 Vdc or more (15 to 28.8 Vdc)
	OFF Voltage	5 Vdc or less (0 to 5 Vdc)
	ON Current	2.5 mA or more
	OFF Current	1.0 mA or less
Isolation	Method	Photocoupler Isolation
	Between internal logic	500 Vdc
Filtering		0.5 ms x N (N is 0 to 63)
IEC61131-2 edition 3 type		Type 1
Compatibility		Supports 2 wire and 3 wire sensors
Cable type and length		Shielded: Maximum 100 m (328 ft) Non-shielded: 50 m (164 ft)
Terminal blocks		Type: 3.5 mm (0.137 in.) pitch Terminal blocks are removable
Input paralleling		No

High Speed Counter Input Characteristics

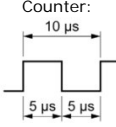
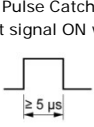
		LT-4201TM
Rated Current	Voltage	24 Vdc
	Current	7.83 mA
Inrush values	Voltage	30 Vdc
	Current	9.99 mA
Input impedance		3.2 kΩ
Input type		Sink/Source
Rated voltage		24 Vdc
Maximum Allowable Voltage		28.8 Vdc
Input limit values	ON Voltage	15 Vdc or more
	OFF Voltage	5 Vdc or less
	ON Current	5 mA or more
	OFF Current	1.5 mA or less
Isolation	Method	Photo coupler Isolation
	Between channels logic	500 Vdc
Filtering		None, 4 μs, 40 μs
IEC61131-2 edition 3 type		Type 1
Compatibility		Supports 2 wire and 3 wire sensors
Cable	Type	Shielded
	Length	Maximum 10 m (33 ft)
Terminal blocks		Type: 3.5 mm (0.137 in.) pitch Terminal blocks are removable
Maximum frequency		<ul style="list-style-type: none"> · 100 kHz is the maximum frequency for Single-phase · 50 kHz is the maximum frequency for 2-phase · Duty Rate: 45 to 55%
Phase Counting Mode		<ul style="list-style-type: none"> · Single phase · 2 Phase x2 · 2 Phase x4 · 2 Phase x2 Reverse · 2 Phase x4 Reverse
Response time	Marker	1 ms
	Preload	1 ms
	Prestrobes	1 ms
	Synchronize output	2 ms
Min. Pulse Width(Pulse input)		<div style="display: flex; justify-content: space-around;"> <div style="text-align: center;"> <p>Counter:</p>  </div> <div style="text-align: center;"> <p>Pulse Catch Input signal ON width</p>  </div> </div>
Input paralleling		No

Transistor Output Characteristics

		LT-4201TM
Rated Voltage		24Vdc
Output range		19.2 to 28.8 Vdc
Output type		Sink/Source
Rated current		DIO: 0.3 A/point, 3.0 A/common AIO and DIO: 0.3 A/point, 1.8 A/common
Residual voltage		1.5 Vdc or less for I = 0.1A
Delay		Off to on (0.3 A load): 1.1ms On to off (0.3 A load): 2ms NOTE: The delay is not including the cable delay.
Isolation	Method	Photocoupler Isolation
	Between internal logic	500 Vdc
Minimum resistor load		80 Ω at 24 Vdc
Cable length		Non-shielded: 150 m (492 ft)
Protection against short circuit		No
Terminal blocks		Type: 3.5 mm (0.137 in.) pitch Terminal blocks are removable

NOTE: Refer to LT4201TM/4301TM Hardware Manual about Protecting Outputs from Inductive Load Damage for additional information on this topic.

Pulse Output/PWM Output/High-speed Counter (Synchronize Output) Characteristics

		LT-4201TM	
Output type		Sink/Source	
Rated voltage		24 Vdc	
Power supply input range		19.2 to 28.8 Vdc	
Power supply reverse protection		Yes	
Pulse Output/PWM output current		50 mA/point, 100 mA/common	
Response time for original input		2 ms	
Isolation resistance	Between fast outputs and internal logic	10 MΩ or more	
	Between power supply port and protective earth ground (PE) = 500 Vdc	10 MΩ or more	
Residual voltage	for I = 0, 1 A	1.5 Vdc or less	
Delay		Off to on (50 mA load): 1.1ms On to off (50 mA load): 1.1ms NOTE: The delay is not including the cable delay.	
Minimum load impedance		80 Ω	
Maximum Pulse output frequency		50 KHz	
Maximum Pulse output frequency		65 kHz	
Accuracy Pulse Output/ PWM Output	Frequency	Accuracy	Duty
	10~100Hz	0.1%	0 to 100%
	101~1000Hz	1%	1 to 99%
	1.001~20kHz	5%	5 to 95%
	20.001~45kHz	10%	10 to 90%
45.001~65kHz	15%	15 to 85%	
Duty rate range		1 to 99%	
Cable	Type	Shielded, including 24 Vdc power supply	
	Length	Maximum 5 m (16 ft)	
Terminal blocks		Type: 3.5 mm (0.137 in.) pitch Terminal blocks are removable	

NOTE: When using the acceleration/deceleration pulse output, there is a 1% maximum error for the frequency.

Analog Input Characteristics

		LT-4201TM	
		AIO and DIO	
Characteristics		Voltage input	Current input
Number of maximum input		2	
Input type		Single-ended	
Input range		-10 to 10 Vdc/0 to 10 Vdc	0 to 20 mA/4 to 20 mA
Input impedance		1 M Ω or more	250 \pm 0.11% Ω
Sample duration time		10 ms per channel + 1 scan time	
Total input system transfer time		20 ms + 1 scan time	
Input tolerance	Maximum deviation at 25°C (77°F) without electromagnetic disturbance	\pm 1% of the full scale	
	Maximum deviation	\pm 2.5% of the full scale	
Digital resolution		13 bits	
Temperature drift		\pm 0.06% of the full scale	
Common mode characteristics		80 db	
Cross talk		60 db	
Non-linearity		\pm 0.4% of full scale	
Input value of LSB		5 mV	10 μ A
Maximum allowed overload (no damages)		\pm 30 Vdc (less than 5 minutes) \pm 15 Vdc (No damage)	\pm 30 mA dc
Protection type		Photo coupler between input and internal circuit	
Cable	Type	Shielded	
	Length	Must be less than 3 m for IEC61131-2 conformance. Maximum transmission distance is 10m.	
Terminal blocks		Type: 3.5 mm (0.137 in.) pitch Terminal blocks are removable	
Isolation	External input	Photo-coupler isolation	
	Between channels	Non-isolated	

Temperature Input (Temperature Probes) Characteristics

		LT-4201TM	
		AIO and DIO	
Input sensor type		Pt100/Pt1000/Ni100/Ni1000	
Input temperature range		Pt100/Pt1000: -200 to 600°C (-328 to 1112°F) Ni100/Ni1000: -20 to 200°C (-4 to 392°F)	
Measuring current	Pt100/Ni100	1.12 mA \pm 3.5%	
	Pt1000/Ni1000	0.242 μ A \pm 3.5%	
Input impedance		Typically 10 M Ω	
Sample duration time		10 ms+1 cycle time	
Wiring type		2-wire or 3-wire connection configured by software for all inputs	
Conversion mode		Sigma delta type	
Input filter		Low pass	
Resolution temperature value		0.1°C (0.18°F)	
Detection type		Open circuit (detection on each channel)	
Input tolerance *1	Maximum deviation at 25°C (77°F) without electromagnetic disturbance	\pm 5°C (41°F)	
	Maximum deviation at 25 to 50°C (77 to 122°F)	Pt type: \pm 5.6°C (42.08°F) Ni type: \pm 5.2°C (41.36°F)	
Temperature drift		30 ppm/°C	
Digital resolution		16 bits	
Rejection in differential mode	50/60 Hz	Typically 60 dB	
Common mode rejection		Typically 80 dB	
Isolation Method		Photocoupler Isolation	
Permitted input signal		\pm 5 Vdc max.	
Cable length	Pt100/Ni100	200 Ω 以下	
	Pt1000/Ni1000	200 Ω 以下	
Terminal blocks		Type: 3.5 mm (0.137 in.) pitch Terminal blocks are removable	
Noise resistance - cable		Shielded cable is necessary	

* 1: Excluding errors caused by the wiring

Temperature Input (Thermocouple) Characteristics

		LT-4201TM
		AIO and DIO
Input sensor type		Thermocouple
Input type range *1		J (-200 to 760°C) (-328 to 1400°F) K (-240 to 1370°C) (-400 to 2498°F) R (0 to 1600°C) (32 to 2912°F) B (200 to 1800°C) (392 to 3272°F) S (0°C to 1600°C) (32 to 2912°F) T (-200 to 400°C) (-328 to 752°F) E (-200 to 900°C) (-328 to 1652°F) N (-200 to 1300°C) (-328 to 2372°F)
Input impedance		Typically 10 MΩ
Sample duration time		10 ms+1 cycle time
Conversion mode		Sigma delta type
Digital resolution		16 bits
Input filter		Low pass
Resolution temperature value		0.1°C (0.18°F) (Type J)
Detection type		Open circuit (detection on each channel)
Input tolerance	Maximum deviation at 25°C (77°F) without electromagnetic disturbance	0.2 % of the full scale, plus standard point of compensation precision at +/- 6°C.
	Maximum deviation	0.28 % of full scale range
Temperature drift		30 ppm/°C
Input tolerance - terminal temperature compensation		± 5°C (41°F) after 10 min.
Cold junction compensation in the temperature range (0 to 50°C (122°F))		Internal cold junction error: +/- 6°C (42.8°F) after operating 45 minutes.
Rejection in differential mode	50/60Hz	Typically 60 dB
Common mode rejection		Typically 80 dB
Isolation Method		Photocoupler Isolation
Permitted input signal		± 5 Vdc max.
Warm up time		45 minutes
Terminal blocks		Type: 3.5 mm (0.137 in.) pitch Terminal blocks are removable
Noise resistance - cable		Shielded cable is necessary

*1: Temperature measurement on PCB at terminal block for cold junction compensation.

Analog Output Characteristics

		LT-4201TM	
		AIO and DIO	
Characteristics		Voltage Output	Current Output
Maximum number of outputs		2	
Output range		-10 to 10 Vdc/0 to 10 Vdc	0 to 20 mA / 4 to 20 mA
Load impedance		2 kΩ or more	300 Ω or more
Application load type		Resistive load	
Setting time		10 ms	
Total output system transfer time		10 ms + 1 scan time	
Input tolerance	Maximum deviation at 25°C (77°F) without electromagnetic disturbance	± 1% of the full scale	
	Maximum deviation	± 2.5% of the full scale	
Digital resolution		12 bits	
Temperature drift		± 0.06% of the full scale	
Output ripple		±50mV	
Cross talk		60 db	
Non-linearity		± 0.5% of full scale	
Output value of LSB		6 mV	12 μA
Protection type		Photo coupler between input and internal circuit	
Output protection		Short circuit protection: Yes Open circuit protection: Yes	
Output behavior if input power supply is less than the power failed threshold		Set to 0	
Cable	Type	Shielded	
	Length	Must be less than 3 m for IEC61131-2 conformance. Maximum transmission distance is 10m.	
Terminal blocks		Type: 3.5 mm (0.137 in.) pitch Terminal blocks are removable	
Isolation	External input	Photo-coupler isolation	
	Between channels	Non-isolated	

External Dimensions/ Panel Cut-out

3.5 Inches Display Module
 <External Dimensions>

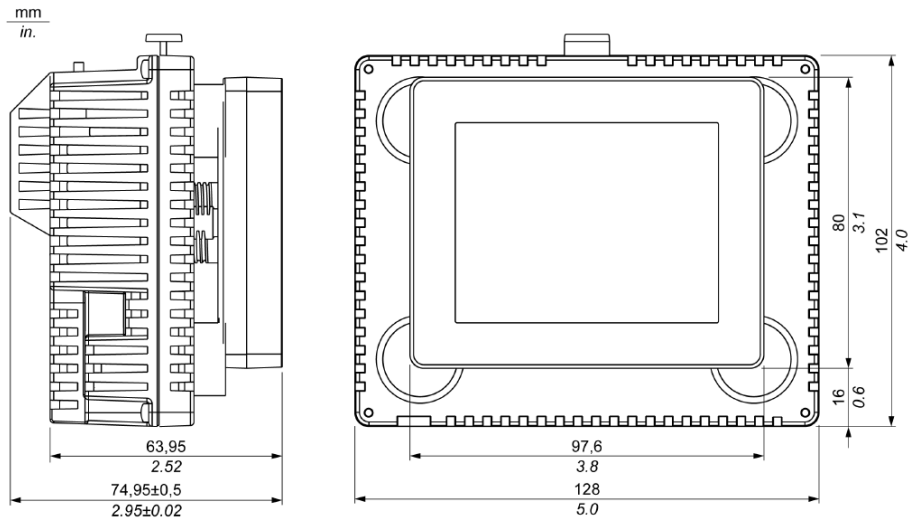

<Panel Cut-out>

mm
in.

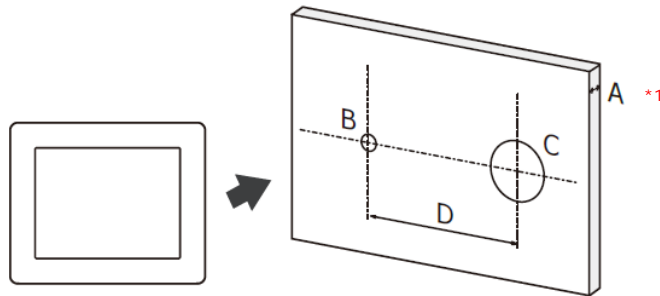

A	B	C	D
1.5 to 6 [0.06 to 0.23]	4.00 [0.15]	22.50 [0.88]	30.00 [1.18]

*1 If rotating torque acted on a display module is 2.5 N.m (22.12 in-lb) or more, use an anti-rotation tee which is supplied with a LT unit. The anti-rotation tee supports up to 6 N.m (53.10 in-lb).

Control Instruction List

Basic Instruction

Normally Open	NO
Normally Closed	NC
Coil (Out)	OUT
Negative out	OUTN
Set	SET
Reset	RST

Positive Transition	PT
Negative Transition	NT

Function Block	FB
Jump	JMP <*P>
Jump to Subroutine	JSR <*P>
Return	RET
Repeat Number of Times (FOR)	FOR
Repeat Number of Times (NEXT)	NEXT
Inverse	INV
Exit	EXIT
Power Bar Control	PBC
Power Bar Reset	PBR
Logic Wait Instruction	LWA

Timer Instruction

On Delay Timer	TON
Off Delay Timer	TOF
Pulse Timer	TP
Accumulated On Delay Timer	TONA
Accumulated Off Delay Timer	TOFA

Counter Instruction

Up Counter	CTU <*P>
Down Counter	CTD <*P>
Up/Down Counter	CTUD <*P>

Read / Write Instruction

Time Read	JRD <*P>
Time Set	JSET <*P>
Date Read	NRD <*P>
Date Set	NSET <*P>

Operation Instruction

Add	ADD <*P>
Subtract	SUB <*P>
Multiplication	MUL <*P>
Division	DIV <*P>
Modulation	MOD <*P>
Increment	INC <*P>
Decrement	DEC <*P>

Time Addition	JADD <*P>
Time Subtraction	JSUB <*P>

Logical AND	AND <*P>
Logical OR	OR <*P>
Logical XOR	XOR <*P>
Logical NOT	NOT <*P>

Move (Copy)	MOV <*P>
Block Move (Block Copy)	BLMV <*P>
Full Move (Full Copy)	FLMV <*P>
Exchange	XCH <*P>

Operation Instruction

Rotate Left	ROL <*P>
Rotate Right	ROR <*P>
Rotate Left with Carry Over	RCL <*P>
Rotate Right with Carry Over	RCR <*P>

Shift Left	SHL <*P>
Shift Right	SHR <*P>
Arithmetic Shift Left	SAL <*P>
Arithmetic Shift Right	SAR <*P>

Function Instruction

Sum	SUM <*P>
Average	AVE <*P>
Square Root	SQRT <*P>
Bit Count	BCNT <*P>
PID	PID

Sine	SIN <*P>
Cosine	COS <*P>
Tangent	TAN <*P>
Arc Sine	ASIN <*P>
Arc Cosine	ACOS <*P>
Arc Tangent	ATAN <*P>
Cotangent	COT <*P>

Exponential	EXP <*P>
Logarithm	LN <*P>
Log Base 10	LG10 <*P>

Compare Instruction

Equal (=)	EQ
Greater Than (>)	GT
Greater Than or Equal To (\geq)	GE
Less Than (<)	LT
Less Than or Equal To (\leq)	LE
Not Equal (\neq)	NE

Time Compare (=)	JEQ
Time Compare (>)	JGT
Time Compare (\geq)	JGE
Time Compare (<)	JLT
Time Compare (\leq)	JLE
Time Compare (\neq)	JNE

Date Compare (=)	NEQ
Date Compare (>)	NGT
Date Compare (\geq)	NGE
Date Compare (<)	NLT
Date Compare (\leq)	NLE
Date Compare (\neq)	NNE

Convert Instruction

BCD Convert	BCD <*P>
BIN Convert	BIN <*P>
Encode	ENCO <*P>
Decode	DECO <*P>
Convert to Radians	RAD <*P>
Convert to Degrees	DEG <*P>
Scale	SCL <*P>

Convert Instruction

Convert Integer to Float	I2F <*P>
Convert Integer to Real	I2R <*P>
Convert Float to Integer	F2I <*P>
Convert Float to Real	F2R <*P>
Convert Real to Integer	R2I <*P>
Convert Real to Float	R2F <*P>
Convert Seconds	H2S <*P>
Convert Seconds to Time	S2H <*P>

Instruction for I/O Driver

Change Pulse Output Parameter	PLSX
Change Acceleration/Deceleration Pulse Output Parameter	PLSY
Read Pulse Output Parameter	PLSG
Start Pulse Output	PLS
Stop Pulse Output	PLSQ
Change PWM Output Parameter	PWMX
Read PWM Output Parameter	PWMG
Start PWM Output	PWM
Stop PWM Output	PWMQ
Change High Speed Counter Parameter	HSCX
Read High Speed Counter Parameter	HSCG
Start High Speed Counter	HSC
Stop High Speed Counter	HSCQ
Confirm Pulse Catch Input	PCH
Clear Pulse Catch Input	PCHQ

Instructions with <*P> correspond to positive transition instructions (differential transition). By adding P to the end of each instruction notation (LMP, etc.), you can use the instruction as a positive transition instruction (e.g., JMPP, JSRP, etc.).

⚠ WARNING

HAZARD OF OPERATOR INJURY, OR UNINTENDED EQUIPMENT DAMAGE

Before operating any of these products, be sure to read all related manuals thoroughly.

Failure to follow these instructions can result in death, serious injury, or equipment damage.

- For printing purposes, the colors in this catalog may differ from those of the actual unit.
- All product names used in this catalog are the registered trademarks or trademarks of their respective companies.
- Actual user screens may differ from the screens shown here.
- All information contained in this catalog is subject to change without notice.
- Electrical equipment should be installed, operated, serviced, and maintained only by qualified personnel. No responsibility is assumed by Digital for any consequences arising out of the use of this material.

Global Headquarters Schneider Electric Japan Holdings Ltd. Pro-face Japan Tokyo, JAPAN Tel: +81 (0)3-5931-7651 www.proface.com	South Korea Pro-face by Schneider Electric Seoul, SOUTH KOREA Tel: +82 (0)2-2630-9850 www.proface.co.kr	North/South American Headquarters Pro-face America, Inc. Pro-face America Ann Arbor, MI, USA Tel: +1 734-477-0600 www.profaceamerica.com	European Headquarters Pro-face Europe B.V. Pro-face Europe Hoofddorp, THE NETHERLANDS Tel: 31 (0)23-55-44-099 www.proface.eu	France Pro-face France Mity-Mory, FRANCE Tel: +33 1-60-21-22-91 www.proface.fr	Poland Pro-face by Schneider Electric Warszawa, POLAND Tel: +48 22-511-83-28 www.proface.pl
Australia/New Zealand Pro-face by Schneider Electric New South Wales, AUSTRALIA Tel: +61 1300-369-233 www.proface.com.au	Singapore Pro-face by Schneider Electric TechPoint, SINGAPORE Tel: +65 6484-7877 www.proface.sg	Brazil Pro-face America Sao Paulo, BRAZIL Tel: +1 734-477-0600 www.profaceamerica.com	Austria Pro-face Austria Leonding, AUSTRIA Tel: +43 732-6933-0 www.proface.at	Germany Pro-face by Schneider Electric Ratingen, GERMANY Tel: +49 2102-404-6322/6323 www.proface.de	Spain and Portugal Pro-face by Schneider Electric Barcelona, SPAIN Tel: +34 93-846-07-45 www.proface.es
China Pro-face China International Trading Shanghai, P.R.CHINA Tel: +86 21-6361-5175 www.proface.com.cn	Taiwan Pro-face by Schneider Electric Taipei, TAIWAN Tel: +886 (0)2-2657-1121 www.proface.com.tw	Canada Pro-face by Schneider Electric Ontario, CANADA Tel: +1 734-477-0600 www.profaceamerica.com	Belgium Pro-face by Schneider Electric Brussels, BELGIUM Tel: +32 (0)2-373-75-02(NL) +32 (0)2-373-75-01(FR) www.proface.be	Italy Pro-face by Schneider Electric Milano, ITALY Tel: +39 (0)11-40-73-333 www.proface.it	Switzerland Pro-face Schweiz GmbH Ittigen BE, SWITZERLAND Tel: +41 43-343-7272 www.proface.ch
India Pro-face by Schneider Electric Bangalore, INDIA Tel: +91 80-4333-3540/3541 www.proface.co.in	Thailand Pro-face by Schneider Electric Bangkok, THAILAND Tel: +66 (0)2-617-5678 www.proface.co.th	Mexico Pro-face America Nuevo Leon, MEXICO Tel: +1 734-477-0600 www.profaceamerica.com	Denmark and Sweden Pro-face by Schneider Electric Ballerup, DENMARK Tel: +45-88-30-23-00 www.proface.dk	The Netherlands Pro-face by Schneider Electric Hoofddorp, THE NETHERLANDS Tel: +31 23-5124-124 www.proface.nl	United Kingdom Pro-face by Schneider Electric Coventry, UNITED KINGDOM Tel: +44 2476-847655 www.proface.co.uk



SCIGATE AUTOMATION (S) PTE LTD

No.1 Bukit Batok Street 22 #01-01 Singapore 659592
 Tel: (65) 6561 0488 Fax: (65) 6562 0588
 Email: sales@scigate.com.sg Web: www.scigate.com.sg
 Business Hours: Monday - Friday 8.30am - 6.15pm